

NGng /en dyi/

NG NG NG NG

ng ng ng ng



ngipin



ngiti



langaw



bungo

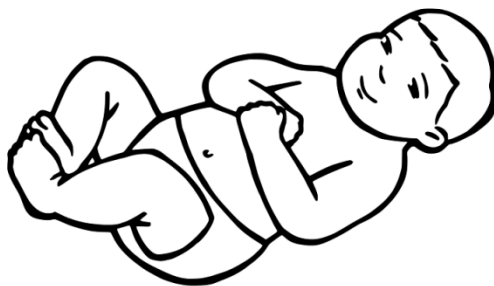

sanggal



saging

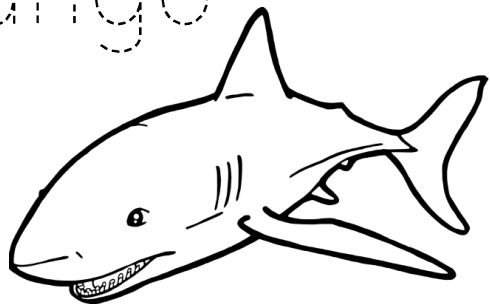

pating

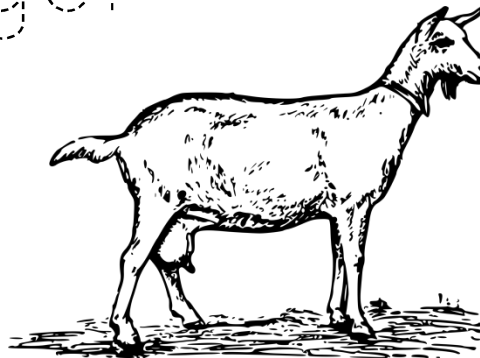

kambing

Oo /o/

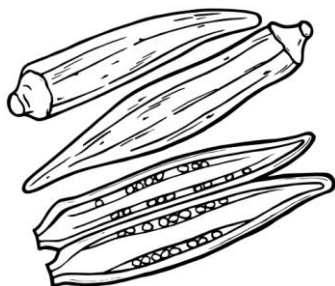
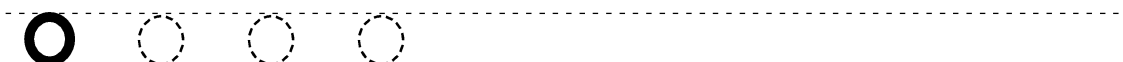
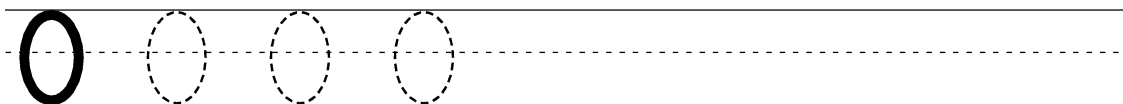

okra

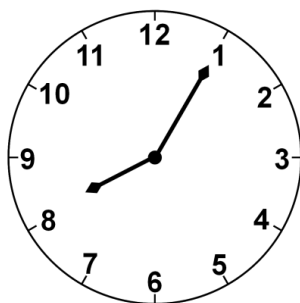

orasán

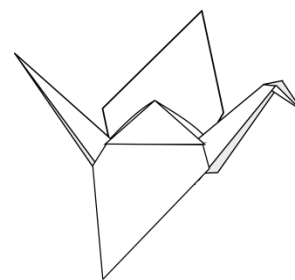

origami

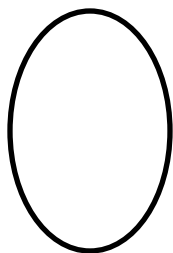

obalo

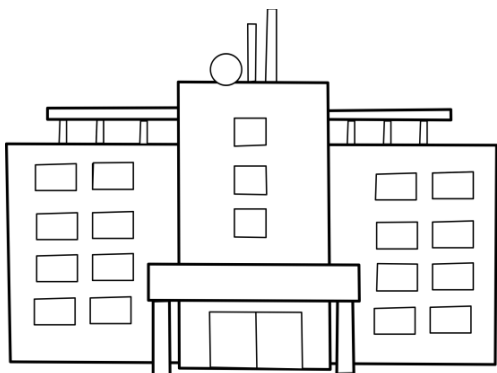
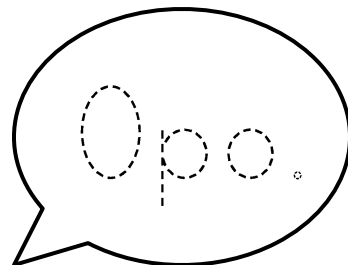

ospital

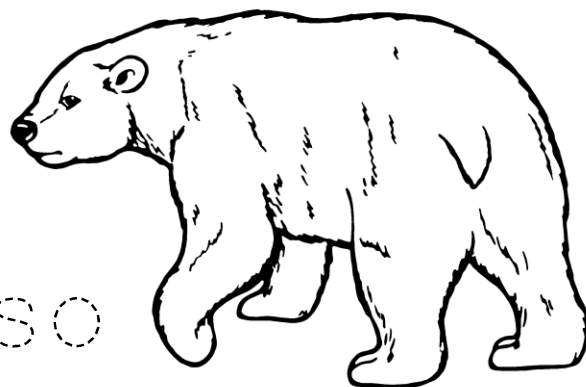

oso

Pp /pi/

P P P P

p p p p

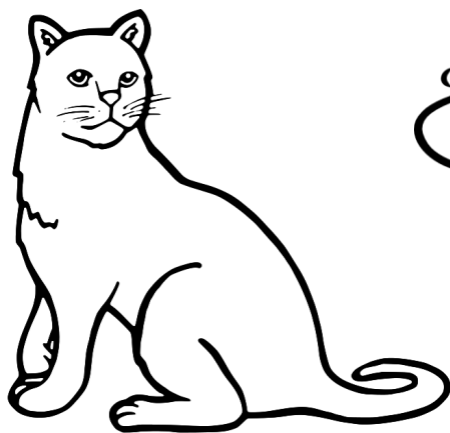

pusa



puno



pako



payong

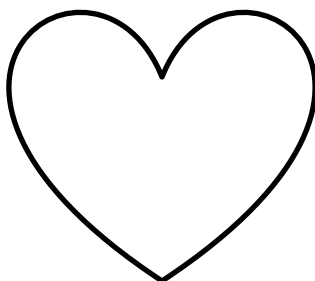

puso

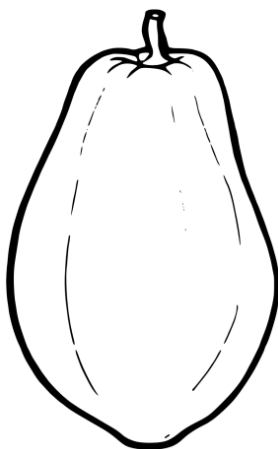

papaya



paruparo

Qq /kyu/

Q Q Q Q

q q q q



Manuel
Quezon

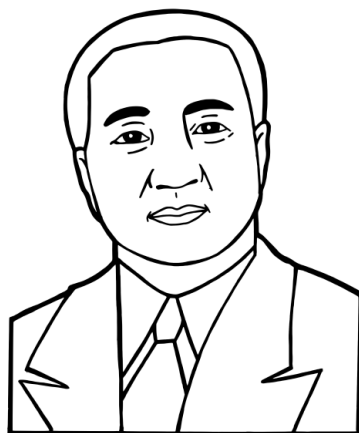

Elpidio
Quirino

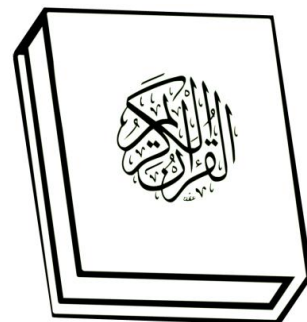

Qur'an

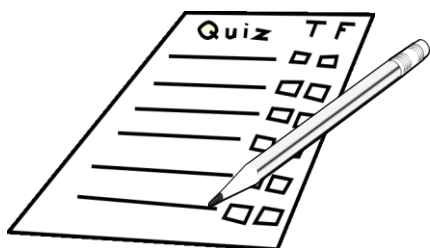

quiz

Antique

Marinduque

Oroquieta

Rr /ar/

R R R R R

r r r r r

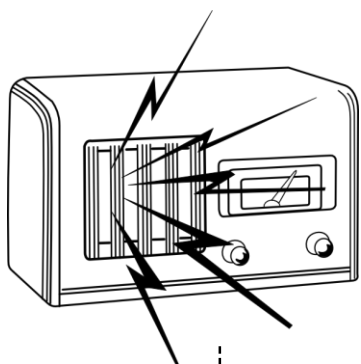

radio



rosas



relos

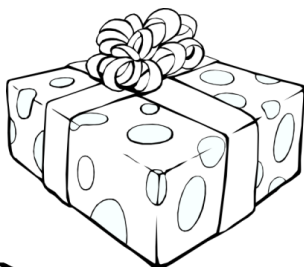

regalo



reyna

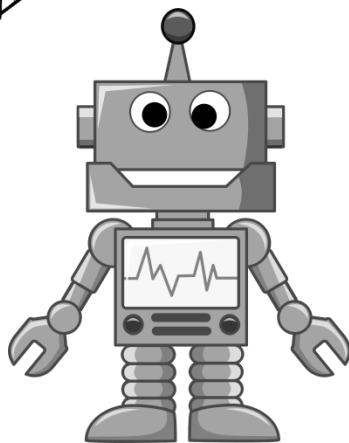

robot



raketa